

tensão de dois vãos de rede de BT com IP.



CEMIG Distribuicao S.A.

Escala: 1:750

Data: 28/02/2016

Assinatura:

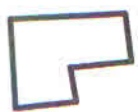

CBA

(4)

10-300

(2)

26M-AB
 U1 10-300

+70AB

26C-AB
 9-150L

9-150L
 -AB

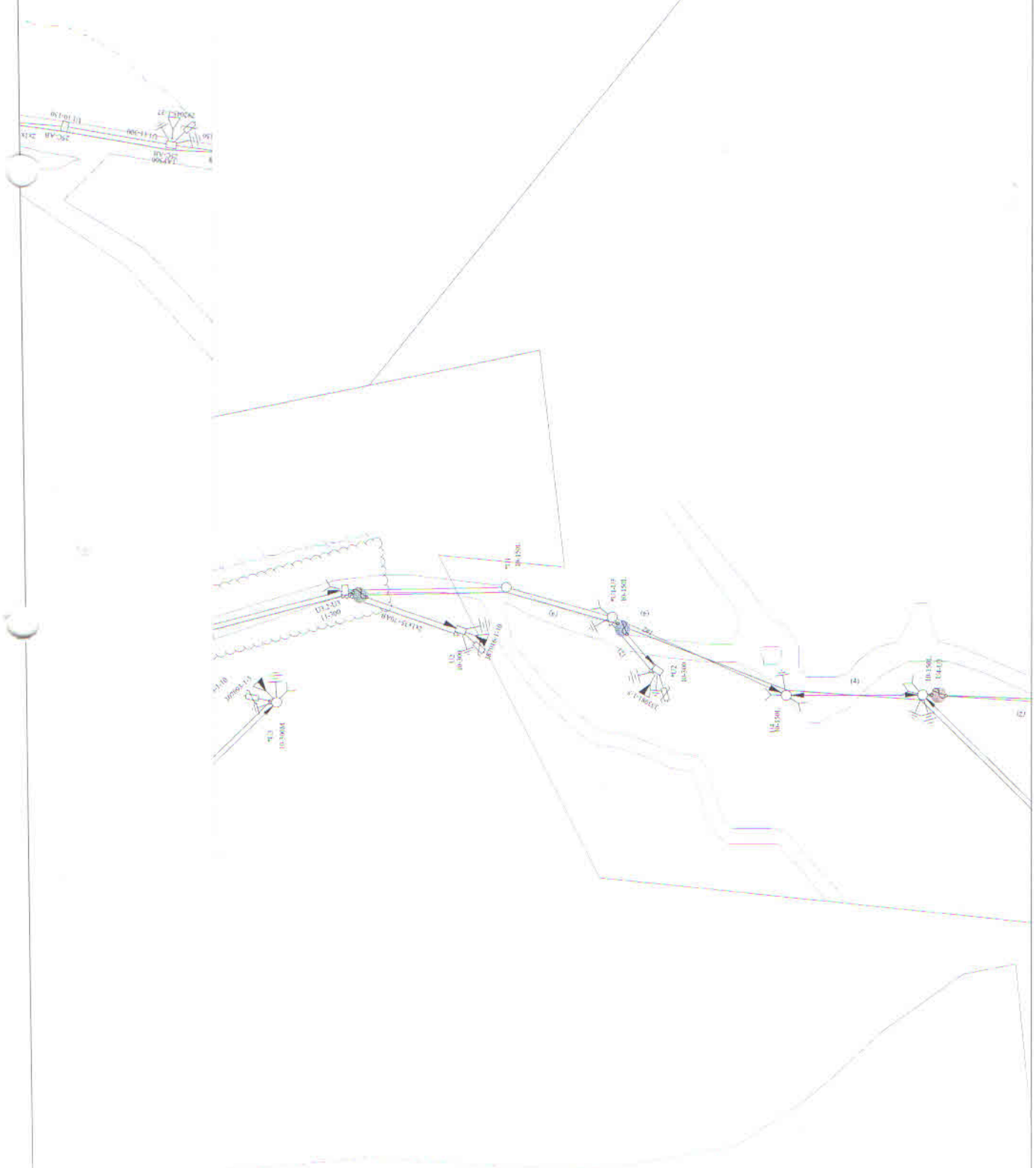

789525

054957

789525

054957

789531

789531

054957



Data: 26/02/2013

Escala: 1:500

CEMIG Distribuição S.A.



RO MUNICIPAL 4/3DÓ/

1#4

U1 10-150
26M-AB

U2 10-600
26M-AB

2#4(4)AB

l 10-150
26M-AB

(4)



No Gemini já consta o Vão de BT existente, mas no local não tem a rede. Orçar apenas a quantidade de cabo e a mão de obra.

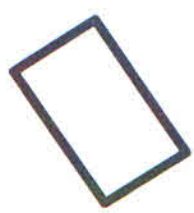

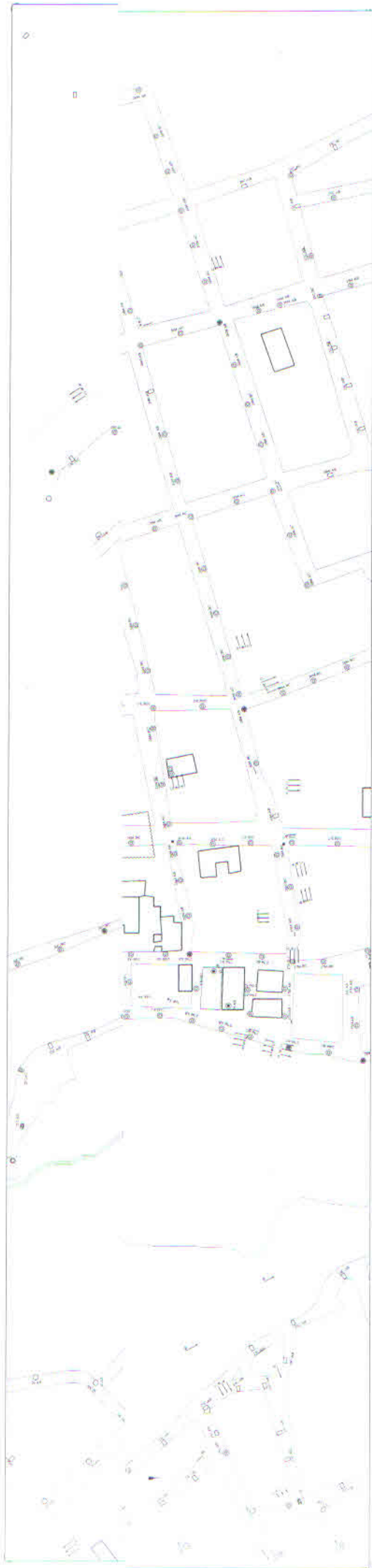

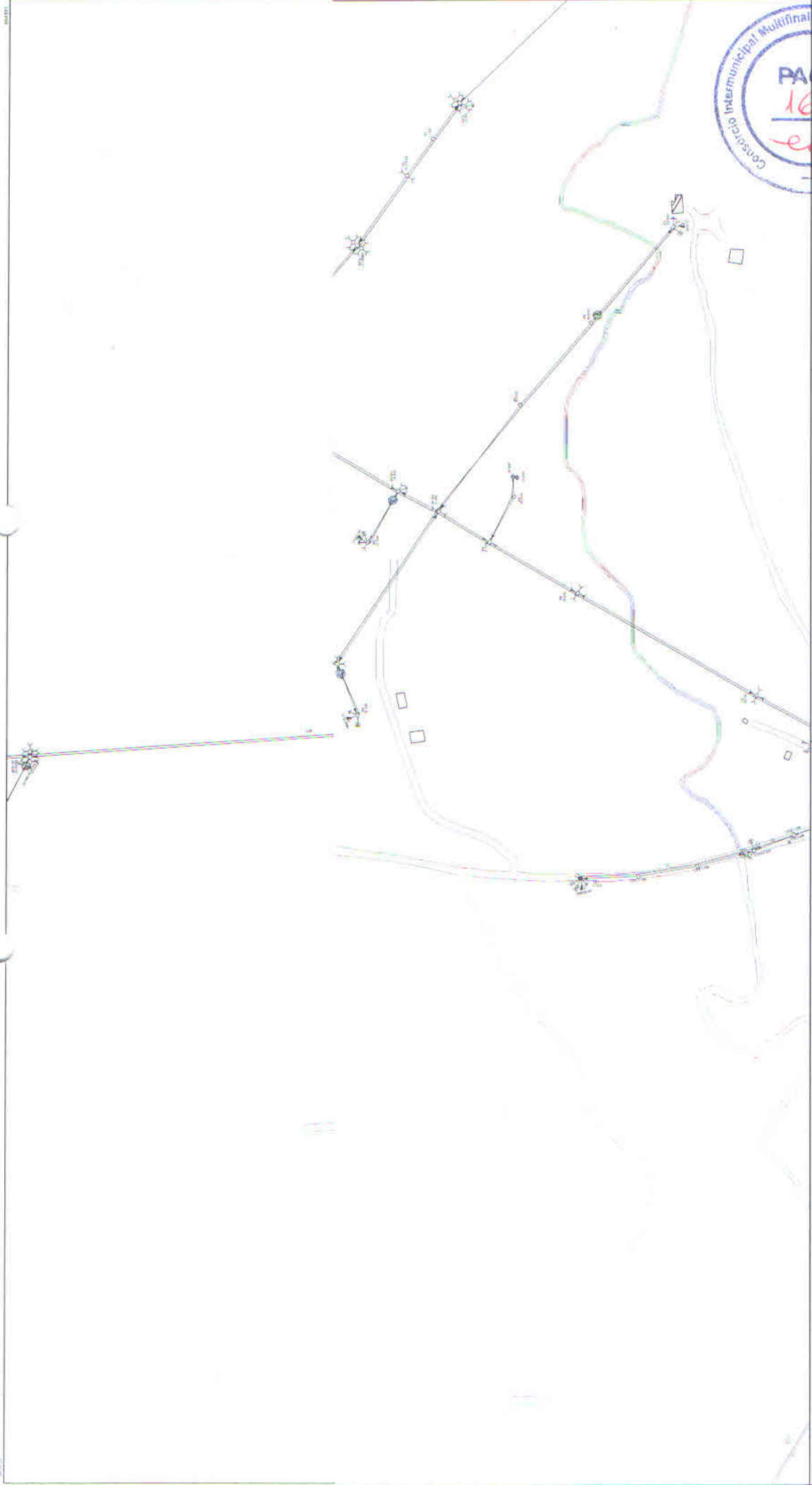

CEMIG Distribuição S.A.

Escala: 1/2000

Outubro/2009



CEMIG Distribuição S.A

Escala: 1:200

Data: 05/07/2019

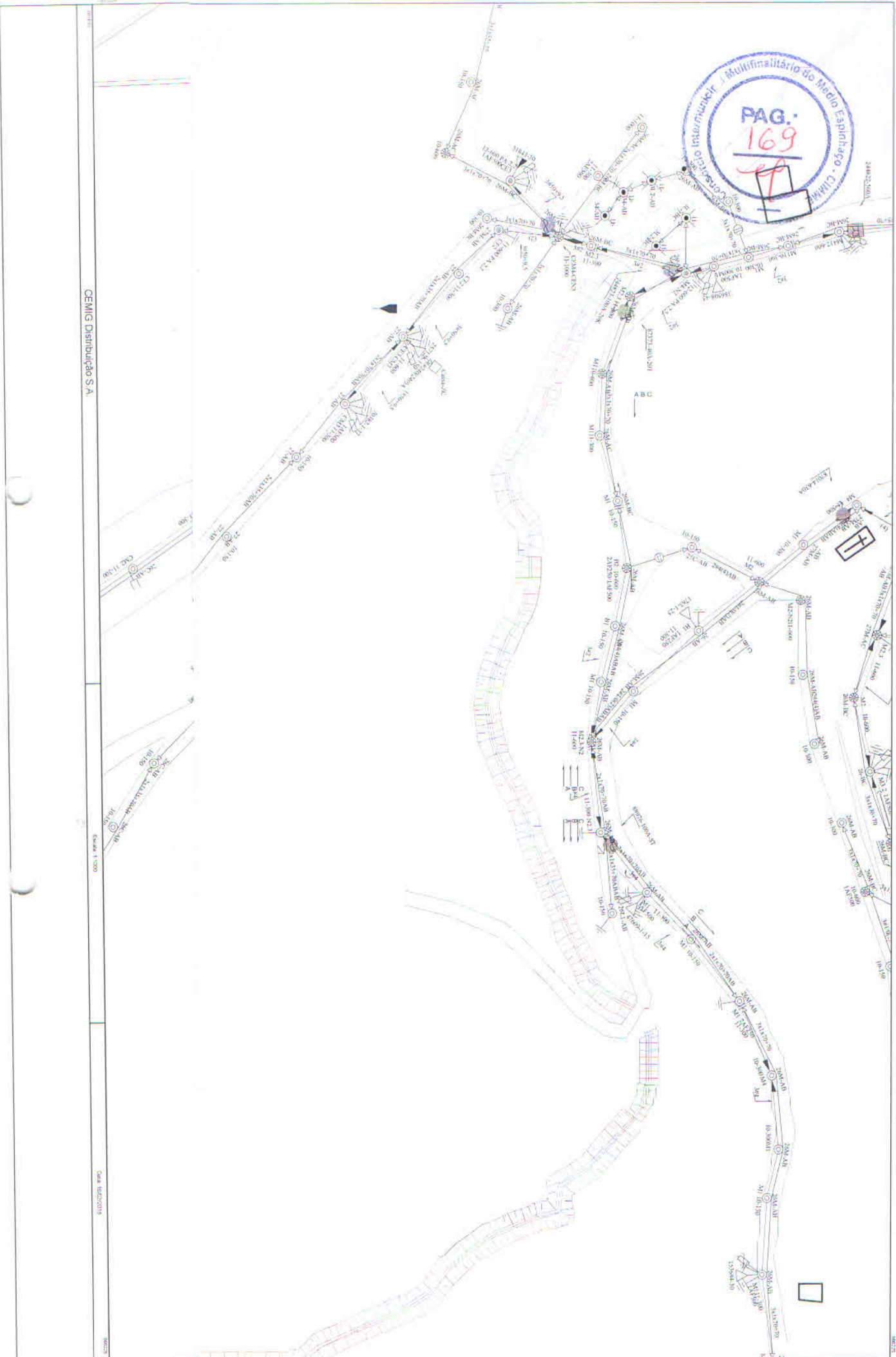

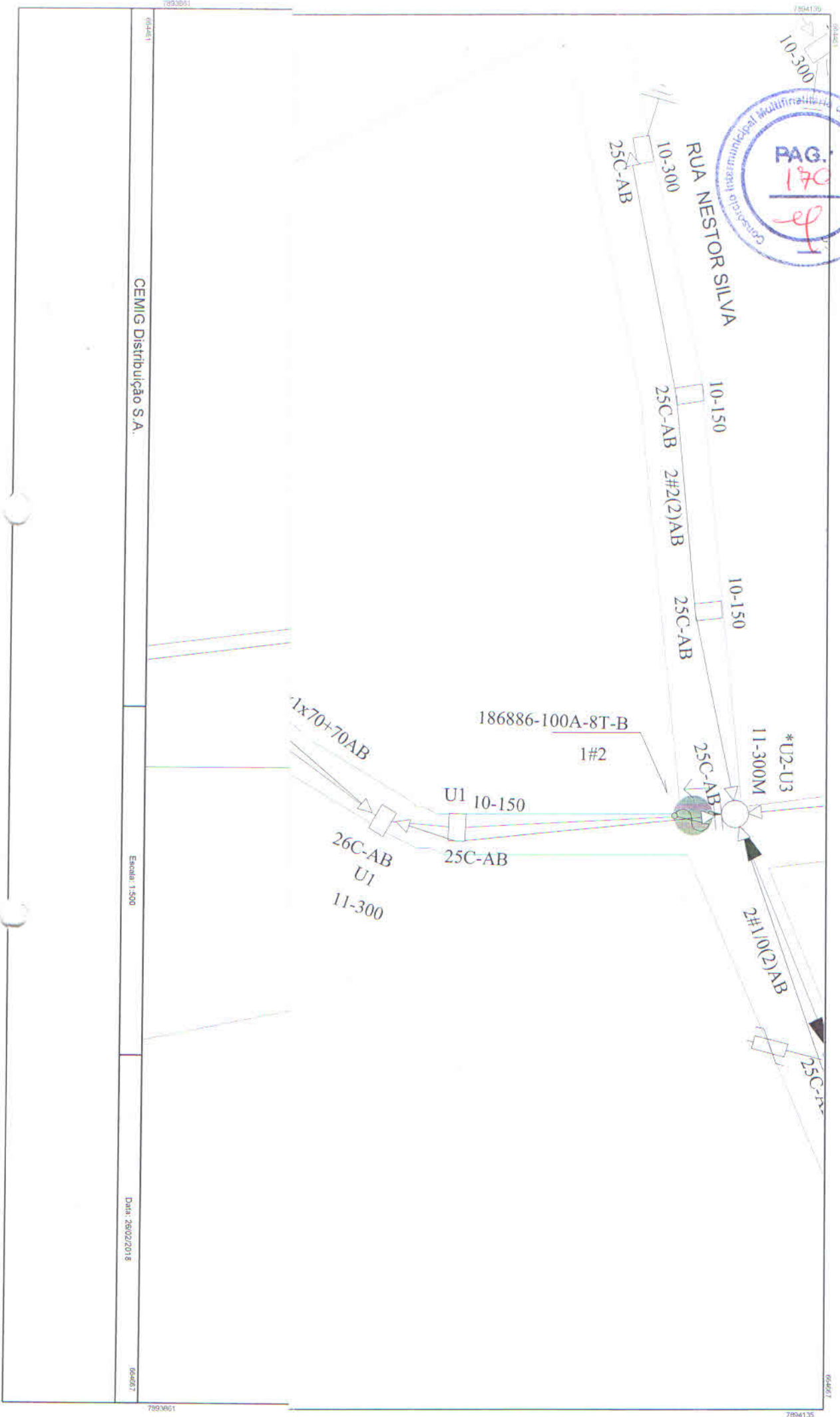

CEMIG Distribuição S.A.

Escala: 1:500

Data: 26/02/2018

664067

7893861

7893861

7894135

7894135

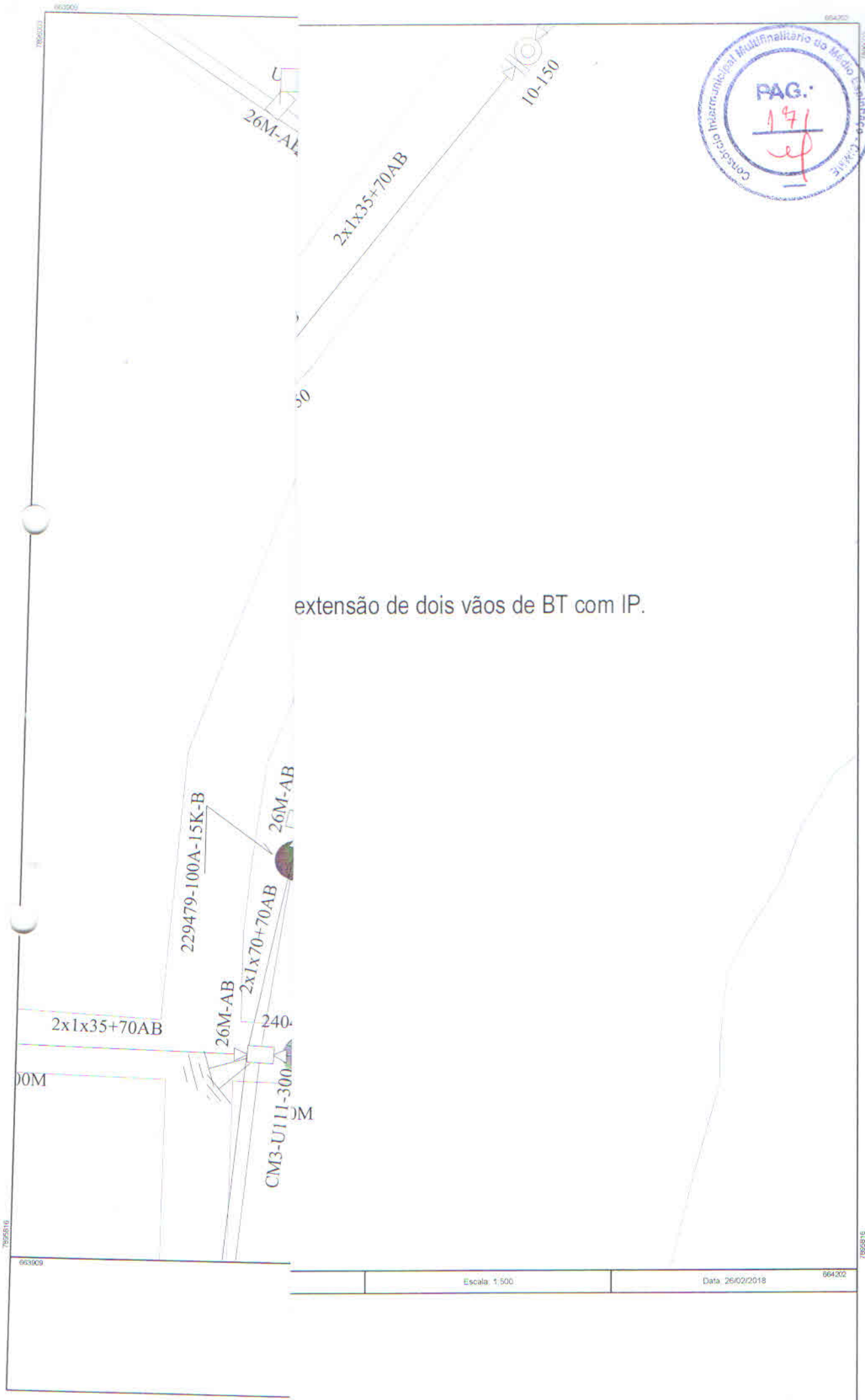

extensão de dois vãos de BT com IP.

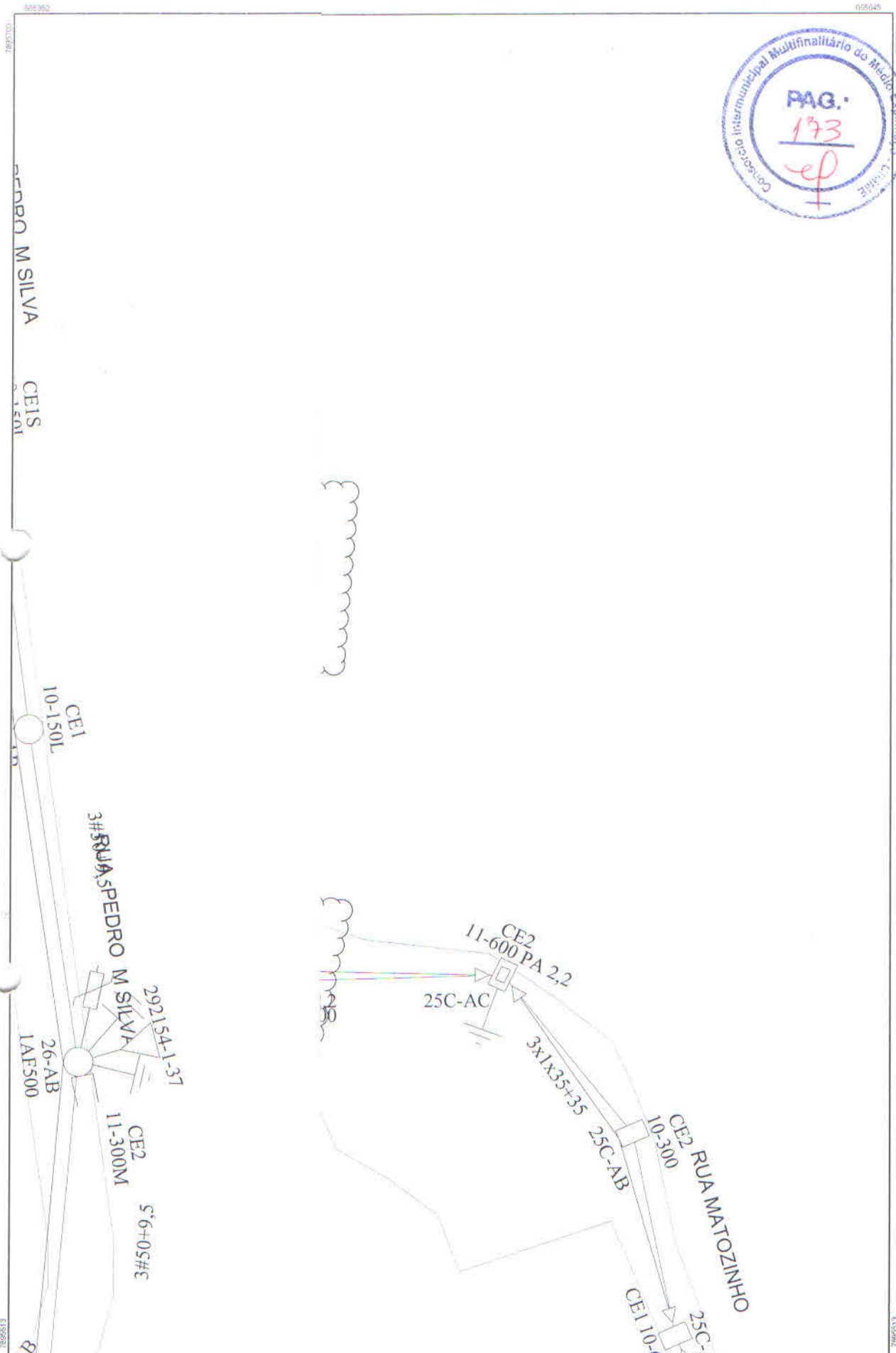

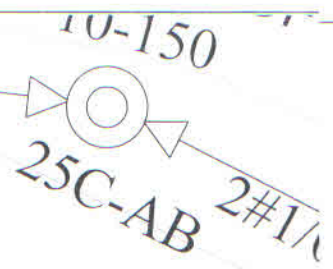

postes com IP
T retirada para os postes instalados e
tro por cabo triplex.

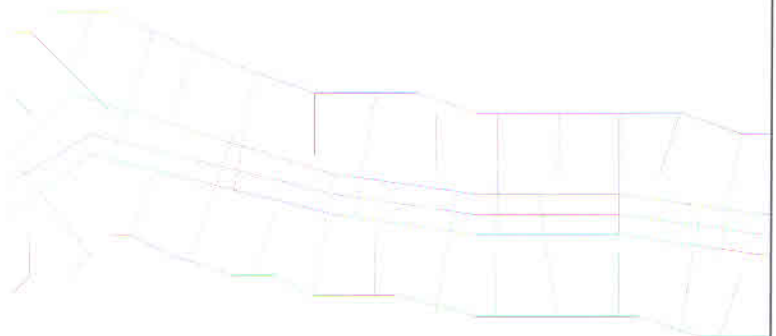

RUA PROF COSTA CHIAB

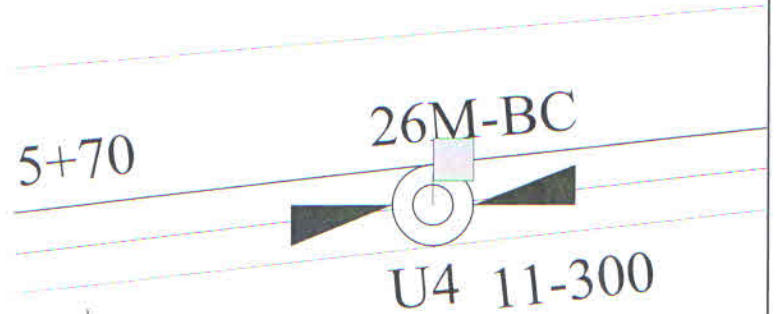

1#4

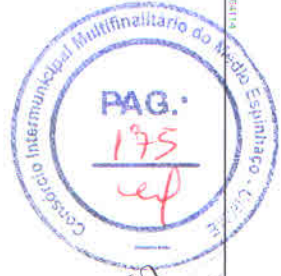

UI 10-150
25C-AB

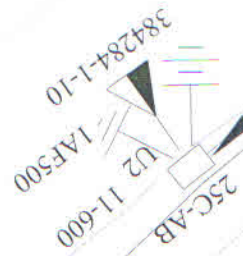

2#1/0(2)AB

10-150
25C-AB

A. A. B. B.

CEMIG Distribuição S.A.

Escala: 1:500

Data: 26/02/2018

664320

7896438

7896712

7896438

7896712



CONGONHAS DO NORTE



Folha 01/14

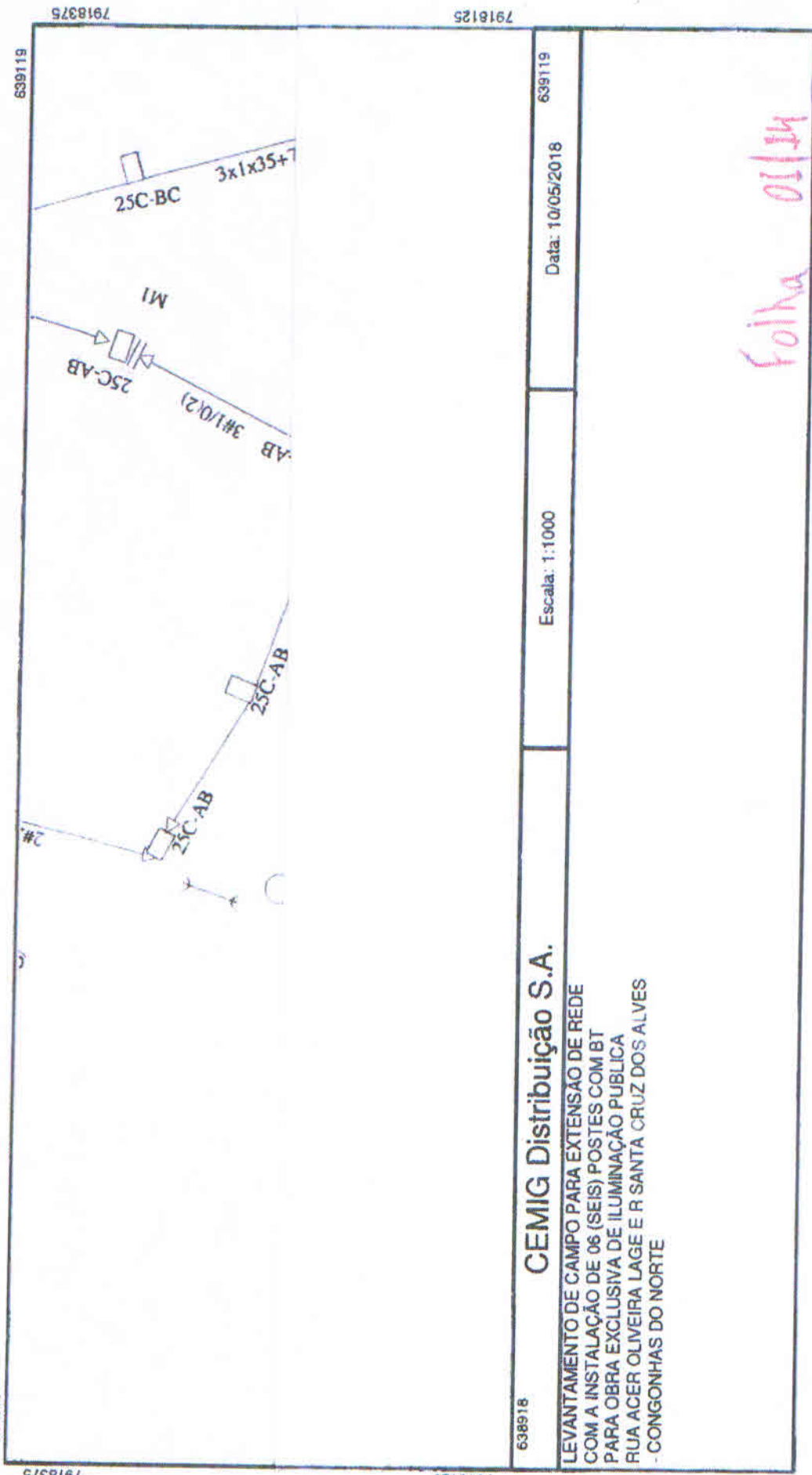

CEMIG Distribuição S.A.

LEVANTAMENTO DE CAMPO PARA EXTENSÃO DE REDE
COM A INSTALAÇÃO DE 06 (SEIS) POSTES COM BT
PARA OBRA EXCLUSIVA DE ILUMINAÇÃO PÚBLICA
RUA ACER OLIVEIRA LAGE E R SANTA CRUZ DOS ALVES
- CONGONHAS DO NORTE

Data: 10/05/2018

Escala: 1:1000

638918

639119

638918

639119

7918375

7918125

7918375

7918125

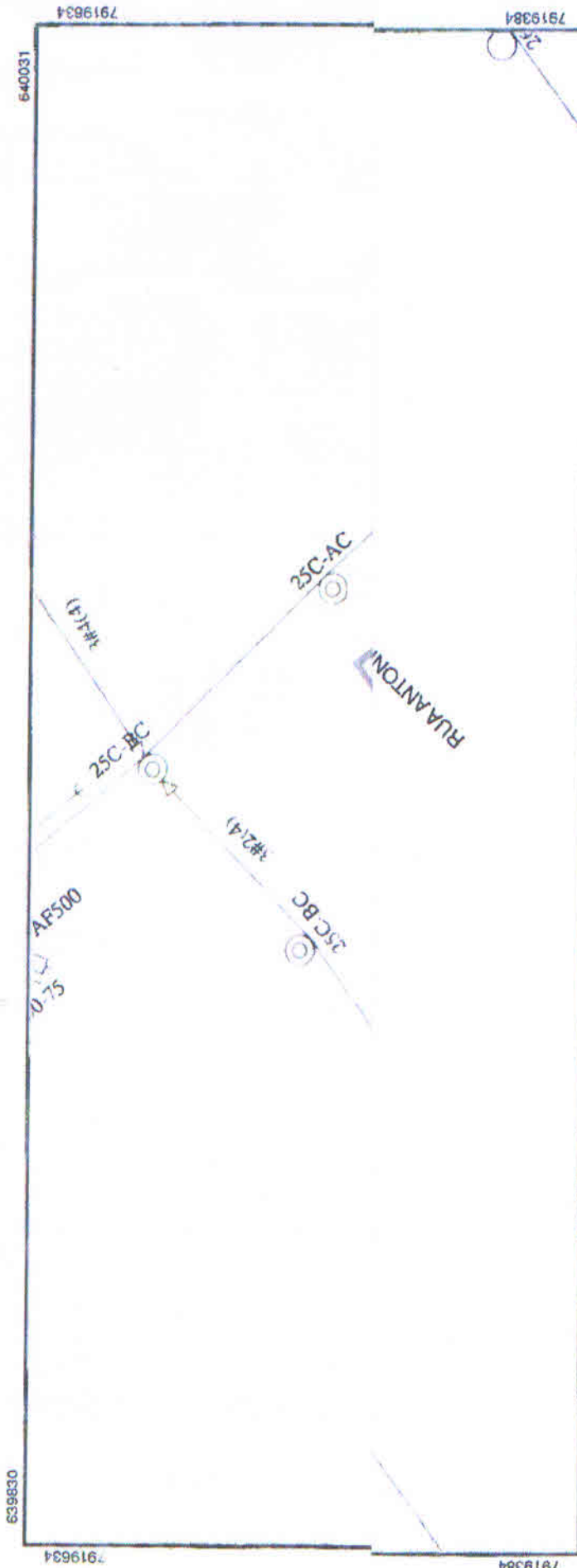

639830

CEMIG Distribuição S.A.

640031

Escala: 1:1000

Data: 10/05/2018

LEVANTAMENTO DE CAMPO PARA INTERCALAR 04
 (QUATRO) POSTES COM BT PARA OBRA EXCLUSIVA
 DE ILUMINAÇÃO PÚBLICA
 RUA TABELIÃO BENTO CORREIA
 CONGONHAS DO NORTE

Folha 02/14

